

Products > Aperture Wafers > A26.00

Aperture Wafers - A26.00

Specifications

Model	A26.00
Inside Diameter	.0034/.0036"
Outside Diameter	.0472/.0475"
Thickness	.0091/.0110"
Radius	.014/.022"
ID Length	.0042/.0046"



Description

Aperture Wafers are precision controlled orifices where the ID Length is controlled very tightly.

Typical Applications

- Hematology Instrumentation
- Ink Jet Printing
- Flow Control

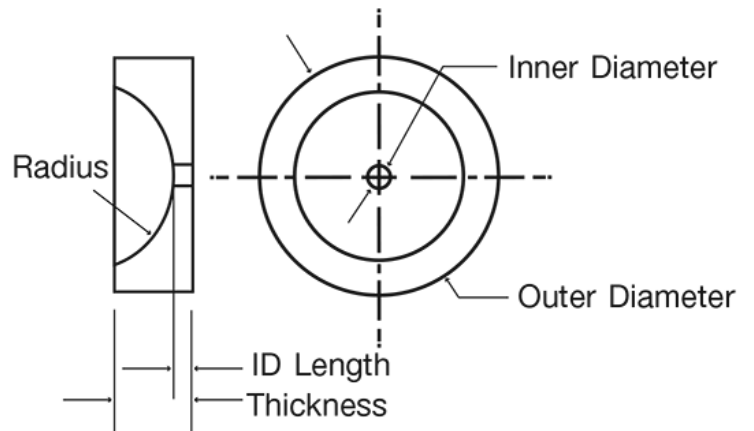

NOT SEEING EXACTLY WHAT YOU NEED?

We specialize in creating a wide range of custom optical components and custom mechanical components including a variety of shapes - from internal holes and tapers to outer flanges, angles and surface finishes. Contact us and we will consult with you to create a custom component that meets all of your specifications.